

HURRICANE RATED

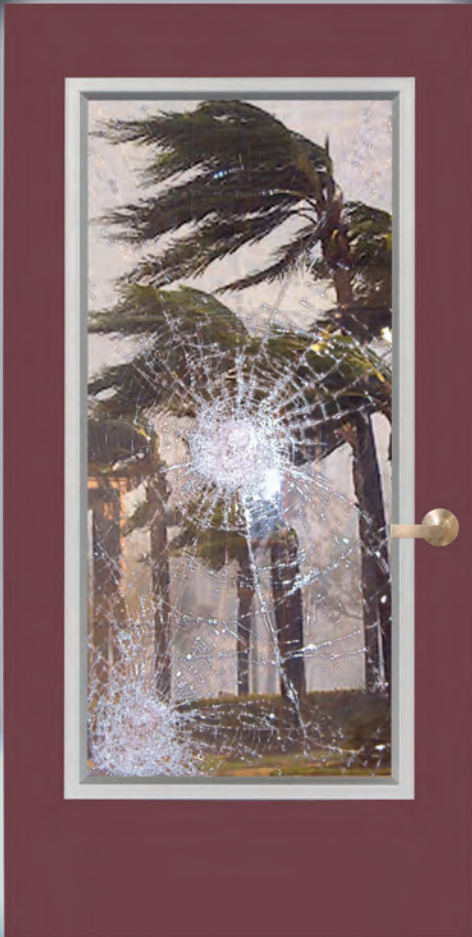

VISION FRAME & DOOR LOUVERS

*Meets ASTM, U.L. and
Florida Building Code Standards*

Vision Frames



Hurricane Rated Vision Frame, Glass and Tape System

- **MATERIAL:** 18 GA. Galvanized Steel, 1/2" clear glass and VHB glazing tape.
- **FINISH:** Grey Primer, Beige, or Bronze Baked Enamel.
- **INSTALLATION:** The StormPro-HR™ is easy to install and provides a low profile, flush to the door look. Uses 1-3/4" sheet metal screws that pass through the door cutout, and fastens to the opposite side of the vision frame. 5/8 x .090 thick conformable HRT-090 glazing tape is supplied and installed on both sides of the glass.
- **DOOR THICKNESS:** For 1-3/4" Approved Metal doors
- **GLAZING:** Glass is comprised of 2 pieces of 3/16" clear annealed with a .120 Uvekol™ "S" clear laminate. Overall glass thickness is 1/2".
- **Maximum Size:** 36" wide x 72" tall cutout (visible lite 33-1/2" x 69-1/2")
- **Optional Features:** Stainless Steel, Custom Baked Enamel Paint Colors, Security Screws
- **Hurricane / Windstorm Approval:** w/ U.L. mark ASTM E330, E1886, E1996 Complies with Florida Building Code Standards

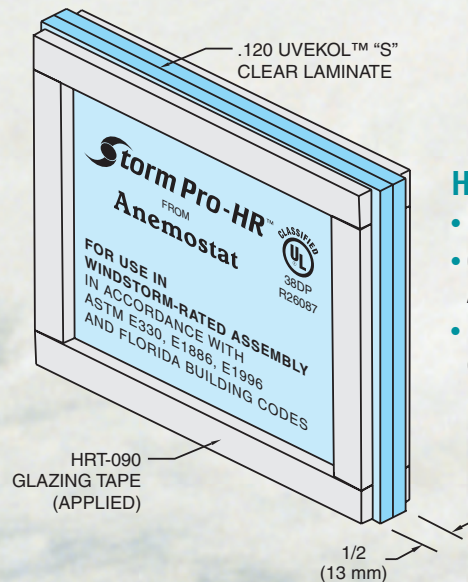
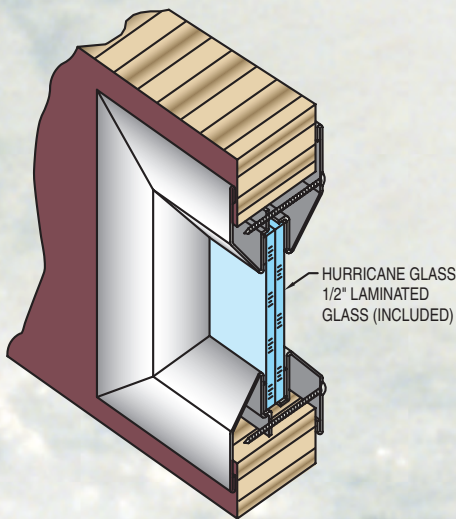
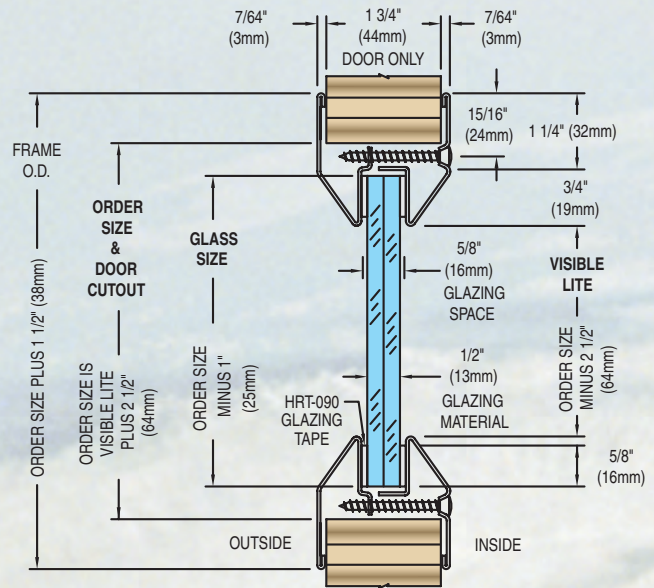

Hurricane Glass

- Easy Installation
- Comes with Tape Applied
- No Messy Silicone or Long Cure Times

Door Louvers

PLSL

Hurricane Rated Door Louver

- **MATERIAL:** 12 GA. Cold Rolled Steel Security Grille Frame (with 13/16 square holes on 1" centers).
20 GA. Cold Rolled Steel - Louver Blades.
- **FINISH:** Grey Primer, Beige or Bronze Baked Enamel.
- **INSTALLATION:** By drilling 1/4" holes thru the door, around the perimeter of the door cutout. Frame has countersunk mounting holes for #8x32 phillips head thru bolts (standard) or one way vandal proof security screws (must specify) with a blank head on one side for flush appearance.
- **DOOR THICKNESS:** For 1 3/4" Doors
- **FREE AIR FLOW:** 50% Free Area.
- **OPTIONAL FEATURES:** Galvanized, Stainless Steel, Custom Baked Enamel Paint Colors, Insect or Bird Screen, Security Screws
- **Hurricane / Windstorm Approval:** w/ U.L. mark ASTM E330, E1886, E1996
Complies with Florida Building Code Standards

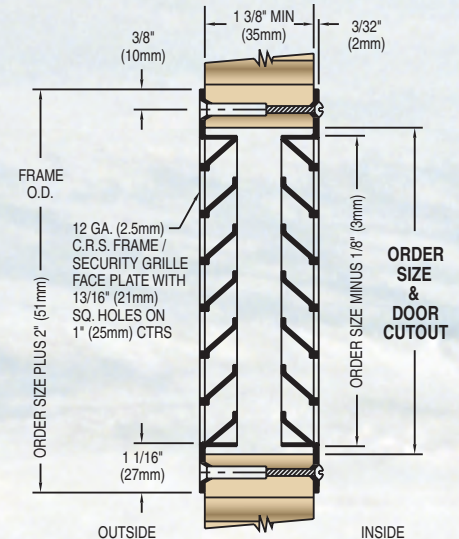
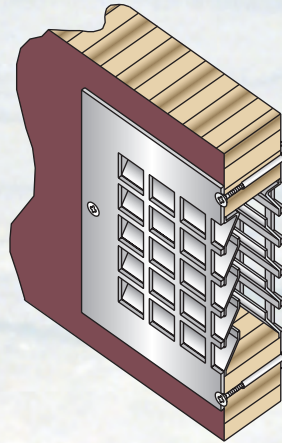

FLDL-UL-SG 1 & 2

Hurricane & Fire Rated Door Louver

- **MATERIAL:** 18 GA. Cold Rolled Steel Louver Blades
12 GA. Cold Rolled Steel Security Grille Frame (with 13/16 square holes on 1" centers).
- **FINISH:** Grey Primer, Beige or Bronze Baked Enamel.
- **INSTALLATION:** Self attaching using #8 x 1" one way vandal proof security screws that fasten the auxiliary frame to the louver core, thru the cut out in the door. The corridor side of the frame is free of fasteners for added security.
- **DOOR THICKNESS:** 1 3/4" Door is Standard. Also available for 2" Door. (to maintain fire rating).
- **CLOSING ASSEMBLY:** Stainless steel operating springs assure proper action with the closing mechanism.
- **FREE AIR FLOW:** 40% Free Area.
- **Hurricane / Windstorm Approval:** w/ U.L. mark ASTM E330, E1886, E1996
Complies with Florida Building Code Standards
- **FIRE TESTED:** w/ U.L. mark
20/45/60/90 minute: Approved Listing

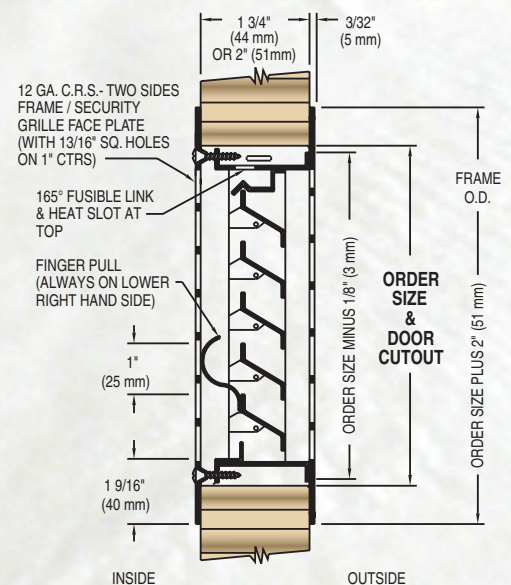
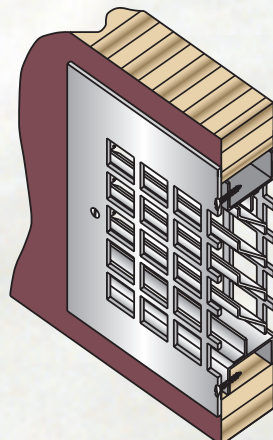

FLDL-UL-SG2 - Shown
FLDL-UL-SG1 - Security Grille
One Side Only

STORMPRO-HR™, PLSL AND FLDL-UL-SG1 & 2 HAVE BEEN SUCCESSFULLY TESTED TO THE FOLLOWING

UNDERWRITERS' LABORATORIES

Hurricane / Windstorm Approval File Number #R26087

ANSI/SDI A250.13

"Testing and Rating of Severe Windstorm Components for Swinging Door Assemblies" (2003)

ASTM E 330

"Standard Test Method for Structural Performance of Exterior Windows, Doors, Skylights, and Curtain Walls by Uniform Static Air Pressure Difference" (2002)

ASTM E 1886

"Standard Test Method for Performance of Exterior Windows, Curtain Walls, Doors, and Storm Shutters Impacted by Missile (s) and Exposed to Cyclic Pressure Differentials" (2005)

ASTM E 1996

"Standard Specification for Performance of Exterior Windows, Curtain Walls, Doors, and Storm Shutters Impacted by Windborne Debris in Hurricanes" (2006)

FLORIDA BUILDING CODE TESTING APPLICATION STANDARDS

Hurricane / Windstorm Approval File Numbers #FL11736 (StormPro-HR™) and #FL11757 (PLSL, FLDL-UL-SG1 & SG2)

Title of Test	Level	Result
Uniform Load Structural (Positive)	+ 105.0 (design pressure 70.0) psf	Pass
Uniform Load Structural (Negative)	- 105.0 (design pressure 70.0) psf	Pass
Impact Resistance (Large Missile Test)	Windzone 4, Level D	Pass
Cyclic Wind Pressure Loading	+/- 70.0 psf	Pass



4958 Stout Dr. #119 • San Antonio, TX 78219 • 210.662.6300 • Fax 210.662.2828
E-mail door@anemostat.com • www.anemostat.com